

DESIGNS
FOR
TOMORROW
BY

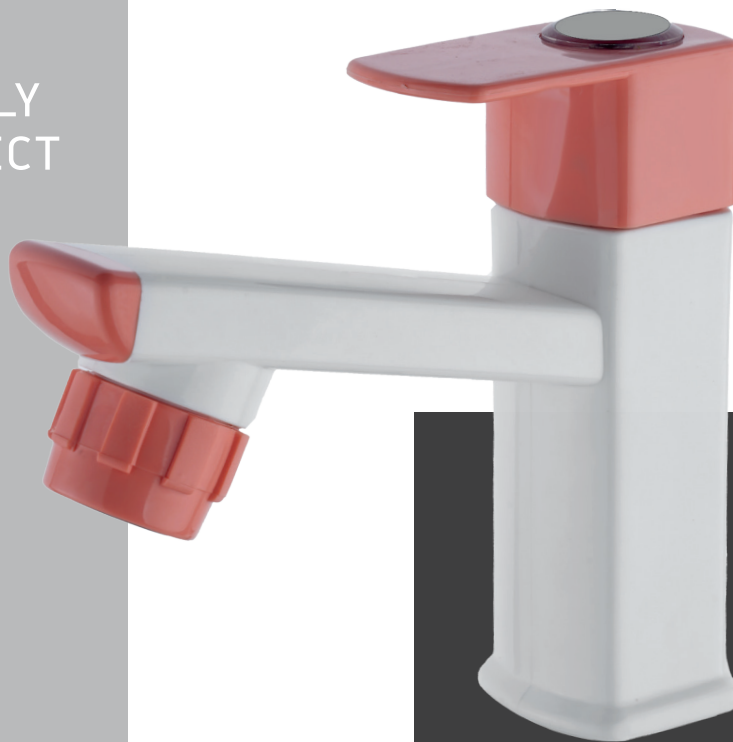

Bell[®]
SANITARY WARES
— the sound of quality —

SIMPLY
PERFECT



PTMT FAUCETS

Maximum Retail Pricelist No.04 effective from October 2025

DESIGNS
FOR TOMORROW
BY  **Bell**[®]
SANITARY WARES
– *the sound of quality* –

Scan
QR Codes
to download ↓
latest
Catalogues



Company Profile



Sanitarywares



Bath Fittings



Kitchen Sinks



Wellness



PTMT Faucets

Innovation That Signifies Quality

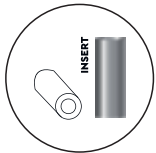

SS INSERT
FOR HIGH
STRENGTH



FOOD
GRADE &
HYGIENIC



IDEAL FOR
HARD
WATER



SCRATCH
RESISTANT



WATER
SAVING
TECHNOLOGY

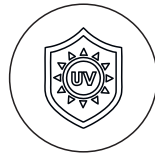

UV-
PROTECTION



LONG
LIFE
DURABILITY



RUST
FREE



TESTED
ON HIGH
PRESSURE

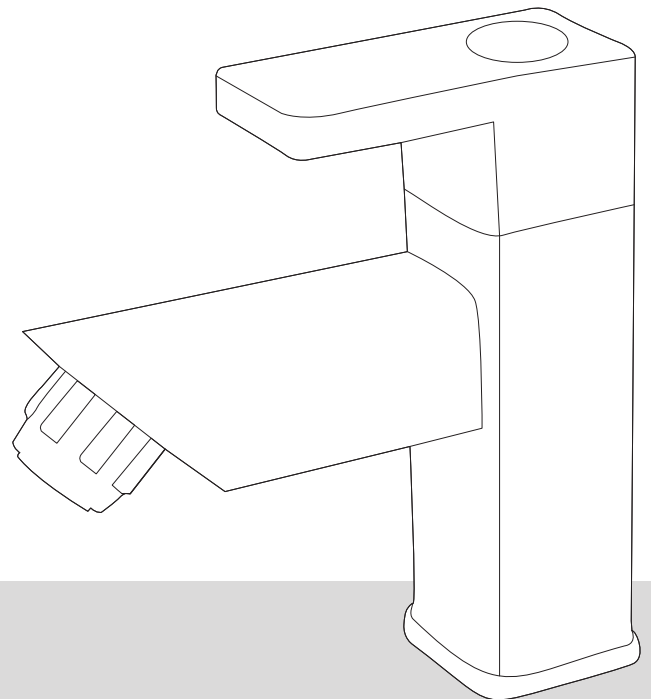

P.T.M.T

(POLYTETRA METHYLENE TEREPHTHALATE)

Index

QUBIX Series White	01
QUBIX Series White Blue	02
EDGE Series White	03
EDGE Series Ivory	04
EDGE Series White Sky Blue	05
EDGE Series White Blue	06
SUPERB Series Ivory	07
SUPERB Series Ivory Golden	08
SUPERB Series White Blue	09
RUBY Series White	10
RUBY Series Gray	11
RUBY Series White/Peach Magenta	12
RUBY Series White/Aqua Green	13
LAVA Series White	14
LAVA Series White Blue	15
LAVA Series White Grey	16
LAVA Series White Black	17
FUSION Series Ivory	18
FUSION Series Ivory Golden	19
FUSION Series White Blue	20
NEXUS Series White	21
NEXUS Series White Blue	22
STANDARD Series Ivory	23
STANDARD Series White	24
HI-FLO Series White	25
HI-FLO Series White Black	26
ABS Shower with Abs Arm	27
PTMT Shower with Arm	27
Health Faucets	28
PTMT Connection Pipe	29
PTMT Floor Trap	30
Allied Accessories	30



Pillar Cock

QUWH-01 ₹ 485/-

10 Pcs. 80 Pcs.



Bib Cock

QUWH-02 ₹ 370/-

24 Pcs. 144 Pcs.

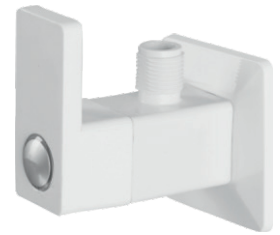

Angular Stop Cock (2 Pc Packing)

QUWH-03 ₹ 320/-

48 Pcs. 288 Pcs.

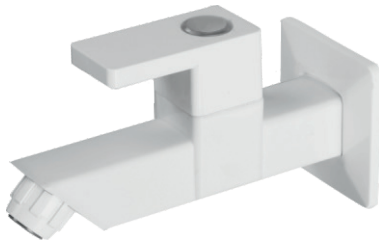

Bib Cock Long Body

QUWH-04 ₹ 440/-

24 Pcs. 144 Pcs.



Sink Cock (Table Mounted)

QUWH-05 ₹ 750/-

10 Pcs. 80 Pcs.



Sink Cock (Wall Mounted)

QUWH-06 ₹ 725/-

10 Pcs. 80 Pcs.



2-Way Bib Cock

QUWH-08 ₹ 705/-

8 Pcs. 64 Pcs.

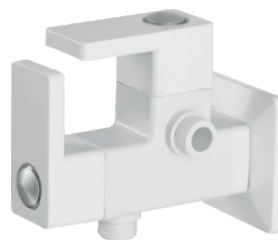

2-Way Angular Stop Cock

QUWH-26 ₹ 685/-

08 Pcs. 64 Pcs.



Wall Mixer With Overhead Shower System

QUWH-20 ₹ 1900/-

04 Pcs. 24 Pcs.



Sink Mixer (Wall Mounted)

QUWH-23 ₹ 1900/-

04 Pcs. 24 Pcs.

P.T.M.T
 (Polytetra Methylene Terephthalate)

Small Box Master Box



Pillar Cock

QUWBL-01 ₹ 485/-

10 Pcs. 80 Pcs.

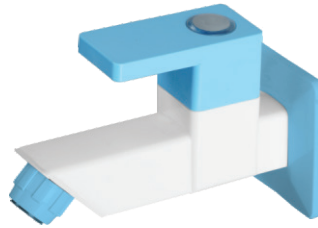

Bib Cock

QUWBL-02 ₹ 370/-

24 Pcs. 144 Pcs.

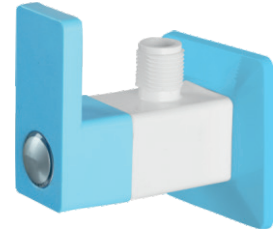

Angular Stop Cock (2 Pc Packing)

QUWBL-03 ₹ 320/-

48 Pcs. 288 Pcs.

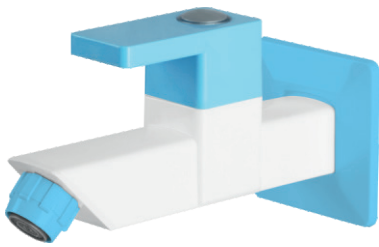

Bib Cock Long Body

QUWBL-04 ₹ 440/-

24 Pcs. 144 Pcs.



Sink Cock (Table Mounted)

QUWBL-05 ₹ 750/-

10 Pcs. 80 Pcs.



Sink Cock (Wall Mounted)

QUWBL-06 ₹ 725/-

10 Pcs. 80 Pcs.



2-Way Bib Cock

QUWBL-08 ₹ 705/-

8 Pcs. 64 Pcs.

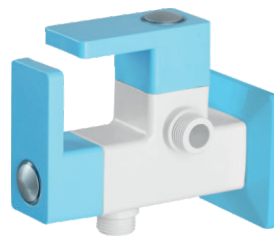

2-Way Angular Stop Cock

QUWBL-26 ₹ 685/-

08 Pcs. 64 Pcs.



Wall Mixer With Overhead Shower System

QUWBL-20 ₹ 1900/-

04 Pcs. 24 Pcs.

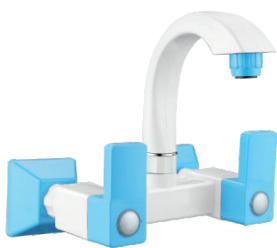

Sink Mixer (Wall Mounted)

QUWBL-23 ₹ 1900/-

04 Pcs. 24 Pcs.

P.T.M.T
 (Polytetra Methylene Terephthalate)

Small Box Master Box



Pillar Cock

EDWH-01 ₹ 485/-

12 Pcs. 48 Pcs.



Bib Cock

EDWH-02 ₹ 370/-

28 Pcs. 112 Pcs.

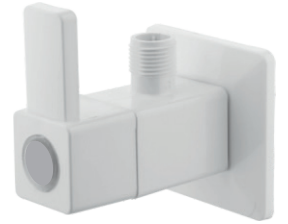

Angular Stop Cock (2 Pc Packing)

EDWH-03 ₹ 320/-

56 Pcs. 224 Pcs.



Bib Cock Long Body

EDWH-04 ₹ 440/-

12 Pcs. 48 Pcs.



Sink Cock (Table Mounted)

EDWH-05 ₹ 750/-

12 Pcs. 48 Pcs.



Sink Cock (Wall Mounted)

EDWH-06 ₹ 725/-

12 Pcs. 48 Pcs.



2-Way Bib Cock

EDWH-08 ₹ 705/-

12 Pcs. 48 Pcs.



2-Way Angular Stop Cock (2 Pc Packing)

EDWH-26 ₹ 685/-

24 Pcs. 96 Pcs.



Wall Mixer With Overhead Shower System

EDWH-20 ₹ 1900/-

01 Pcs. 16 Pcs.



Sink Mixer (Wall Mounted)

EDWH-23 ₹ 1900/-

01 Pcs. 16 Pcs.



Wall Mixer Non-Telephonic

EDWH-15 ₹ 1800/-

01 Pcs. 16 Pcs.

P.T.M.T
 (Polytetra Methylene Terephthalate)

Small Box Master Box



Pillar Cock

EDIV-01 ₹ 485/-

12 Pcs. 48 Pcs.



Bib Cock

EDIV-02 ₹ 370/-

28 Pcs. 112 Pcs.

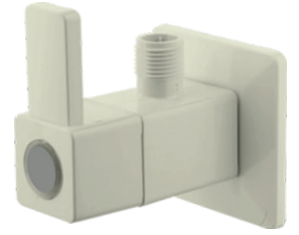

Angular Stop Cock (2 Pc Packing)

EDIV-03 ₹ 320/-

56 Pcs. 224 Pcs.



Bib Cock Long Body

EDIV-04 ₹ 440/-

12 Pcs. 48 Pcs.



Sink Cock (Table Mounted)

EDIV-05 ₹ 750/-

12 Pcs. 48 Pcs.



Sink Cock (Wall Mounted)

EDIV-06 ₹ 725/-

12 Pcs. 48 Pcs.



2-Way Bib Cock

EDIV-08 ₹ 705/-

12 Pcs. 48 Pcs.



2-Way Angular Stop Cock (2 Pc Packing)

EDIV-26 ₹ 685/-

24 Pcs. 96 Pcs.



Wall Mixer With Overhead Shower System

EDIV-20 ₹ 1900/-

01 Pcs. 16 Pcs.



Sink Mixer (Wall Mounted)

EDIV-23 ₹ 1900/-

01 Pcs. 16 Pcs.

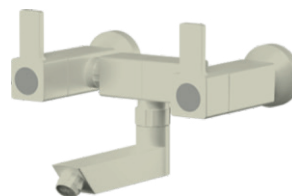

Wall Mixer Non-Telephonic

EDIV-15 ₹ 1800/-

01 Pcs. 16 Pcs.

P.T.M.T
 (Polytetra Methylene Terephthalate)

Small Box Master Box



Pillar Cock

EDWSB-01 ₹ 485/-

12 Pcs. 48 Pcs.



Bib Cock

EDWSB-02 ₹ 370/-

28 Pcs. 112 Pcs.

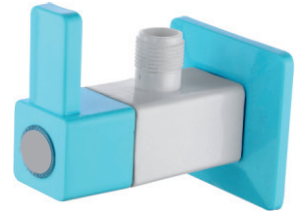

Angular Stop Cock (2 Pc Packing)

EDWSB-03 ₹ 320/-

56 Pcs. 224 Pcs.

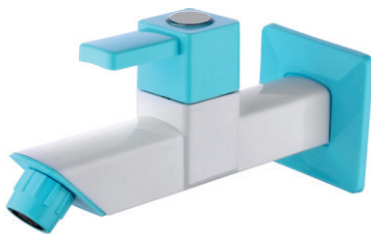

Bib Cock Long Body

EDWSB-04 ₹ 440/-

12 Pcs. 48 Pcs.



Sink Cock (Table Mounted)

EDWSB-05 ₹ 750/-

12 Pcs. 48 Pcs.



Sink Cock (Wall Mounted)

EDWSB-06 ₹ 725/-

12 Pcs. 48 Pcs.

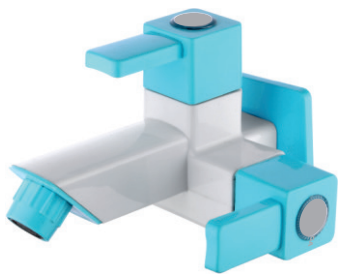

2-Way Bib Cock

EDWSB-08 ₹ 705/-

12 Pcs. 48 Pcs.

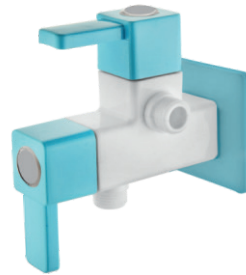

2-Way Angular Stop Cock (2 Pc Packing)

EDWSB-26 ₹ 685/-

24 Pcs. 96 Pcs.



Wall Mixer With Overhead Shower System

EDWSB-20 ₹ 1900/-

01 Pcs. 16 Pcs.



Sink Mixer (Wall Mounted)

EDWSB-23 ₹ 1900/-

01 Pcs. 16 Pcs.

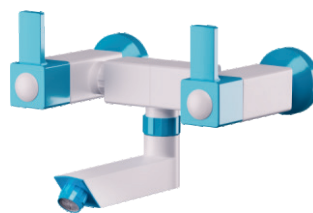

Wall Mixer Non-Telephonic

EDWSB-15 ₹ 1800/-

01 Pcs. 16 Pcs.

P.T.M.T
 (Polytetra Methylene Terephthalate)

Small Box Master Box



Pillar Cock

EDWBL-01 ₹ 485/-

10 Pcs. 80 Pcs.

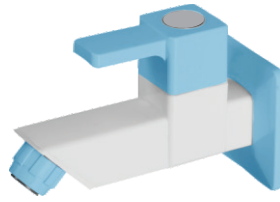

Bib Cock

EDWBL-02 ₹ 370/-

24 Pcs. 144 Pcs.

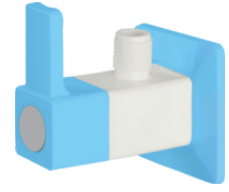

Angular Stop Cock (2 Pc Packing)

EDWBL-03 ₹ 320/-

48 Pcs. 288 Pcs.

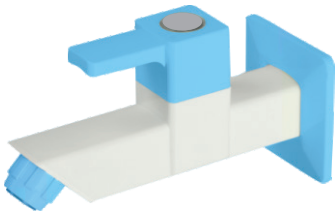

Bib Cock Long Body

EDWBL-04 ₹ 440/-

24 Pcs. 144 Pcs.



Sink Cock (Table Mounted)

EDWBL-05 ₹ 750/-

10 Pcs. 80 Pcs.



Sink Cock (Wall Mounted)

EDWBL-06 ₹ 725/-

10 Pcs. 80 Pcs.



Sink Mixer (Table Mounted)

EDWBL-07 ₹ 1900/-

04 Pcs. 24 Pcs.



2-Way Bib Cock

EDWBL-08 ₹ 705/-

08 Pcs. 64 Pcs.



2-Way Angular Stop Cock

EDWBL-26 ₹ 685/-

08 Pcs. 64 Pcs.



Wall Mixer With Overhead Shower System

EDWBL-20 ₹ 1900/-

04 Pcs. 24 Pcs.



Sink Mixer (Wall Mounted)

EDWBL-23 ₹ 1900/-

04 Pcs. 24 Pcs.



Wall Mixer Non-Telephonic

EDWBL-15 ₹ 1800/-

04 Pcs. 24 Pcs.



Pillar Cock

SUIV-01 ₹ 500/-

10 Pcs. 80 Pcs.



Bib Cock

SUIV-02 ₹ 400/-

24 Pcs. 144 Pcs.



Angular Stop Cock (2 Pc Packing)

SUIV-03 ₹ 335/-

48 Pcs. 288 Pcs.



Bib Cock Long Body

SUIV-04 ₹ 490/-

24 Pcs. 144 Pcs.



Sink Cock (Table Mounted)

SUIV-05 ₹ 790/-

10 Pcs. 80 Pcs.



Sink Cock (Wall Mounted)

SUIV-06 ₹ 840/-

10 Pcs. 80 Pcs.



2-Way Bib Cock

SUIV-08 ₹ 680/-

08 Pcs. 64 Pcs.

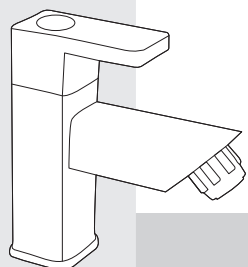

P.T.M.T
 (Polytetra Methylene Terephthalate)

Small Box Master Box



Pillar Cock

SUIGN-01 ₹ 500/-

10 Pcs. 80 Pcs.



Bib Cock

SUIGN-02 ₹ 400/-

24 Pcs. 144 Pcs.

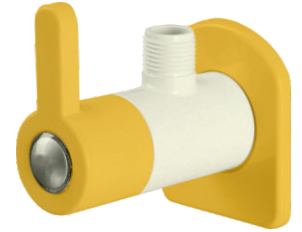

Angular Stop Cock(2 Pc Packing)

SUIGN-03 ₹ 335/-

48 Pcs. 288 Pcs.

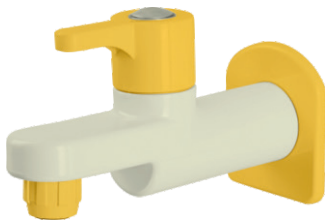

Bib Cock Long Body

SUIGN-04 ₹ 490/-

24 Pcs. 144 Pcs.



Sink Cock (Table Mounted)

SUIGN-05 ₹ 790/-

10 Pcs. 80 Pcs.



Sink Cock (Wall Mounted)

SUIGN-06 ₹ 840/-

10 Pcs. 80 Pcs.



2-Way Bib Cock

SUIGN-08 ₹ 680/-

08 Pcs. 64 Pcs.

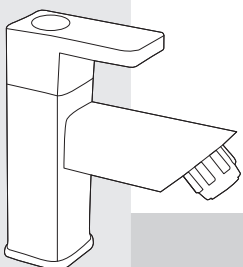

P.T.M.T
 (Polytetra Methylene Terephthalate)

Small Box Master Box



Pillar Cock

SUWBL-01 ₹ 500/-

10 Pcs. 80 Pcs.

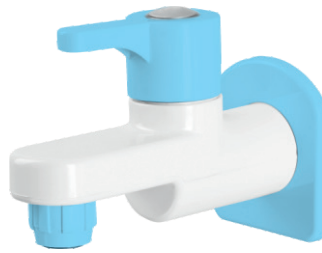

Bib Cock

SUWBL-02 ₹ 400/-

24 Pcs. 144 Pcs.

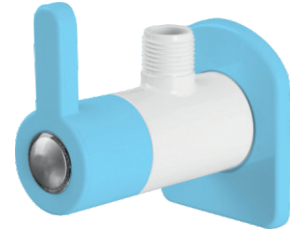

Angular Stop Cock(2 Pc Packing)

SUWBL-03 ₹ 335/-

48 Pcs. 288 Pcs.

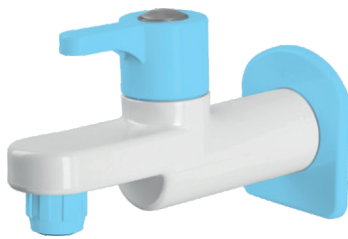

Bib Cock Long Body

SUWBL-04 ₹ 490/-

24 Pcs. 144 Pcs.



Sink Cock (Table Mounted)

SUWBL-05 ₹ 790/-

10 Pcs. 80 Pcs.



Sink Cock (Wall Mounted)

SUWBL-06 ₹ 840/-

10 Pcs. 80 Pcs.

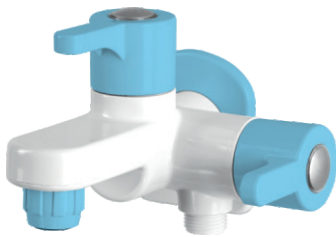

2-Way Bib Cock

SUWBL-08 ₹ 680/-

08 Pcs. 64 Pcs.



Wall Mixer With Overhead Shower System

FUWBL-20 ₹ 1900/-

04 Pcs. 24 Pcs.



Nozzle Bib Cock

SUWBL-34 ₹ 440/-

24 Pcs. 144 Pcs.

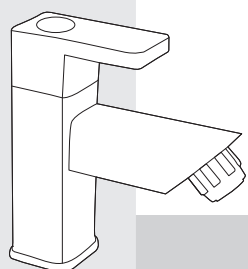

P.T.M.T
 (Polytetra Methylene Terephthalate)

Small Box Master Box



Pillar Cock

RUWH-01 ₹ 355/-

 24 Pcs.  96 Pcs.



Bib Cock

RUWH-02 ₹ 220/-

 48 Pcs.  192 Pcs.

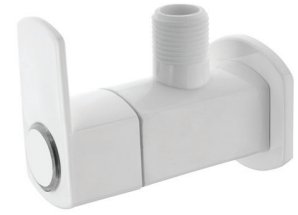

**Angular Stop Cock
 (O2 PC Packing)**

RUWH-03 ₹ 210/-

 56 Pcs.  224 Pcs.



Bib Cock Long Body

RUWH-04 ₹ 280/-

 24 Pcs.  96 Pcs.



Sink Cock (Table Mounted)

RUWH-05 ₹ 535/-

 12 Pcs.  48 Pcs.



Sink Cock (Wall Mounted)

RUWH-06 ₹ 535/-

 12 Pcs.  48 Pcs.



2-Way Bib Cock

RUWH-08 ₹ 455/-

 24 Pcs.  96 Pcs.



2-Way Angular Stop Cock

RUWH-26 ₹ 425/-

 28 Pcs.  112 Pcs.

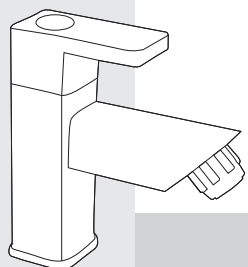

P.T.M.T
 (Polytetra Methylene Terephthalate)

 Small Box  Master Box



Pillar Cock

RUGR-01 ₹ 355/-

 24 Pcs.  96 Pcs.



Bib Cock

RUGR-02 ₹ 220/-

 48 Pcs.  192 Pcs.



**Angular Stop Cock
 (02 PC Packing)**

RUGR-03 ₹ 210/-

 56 Pcs.  224 Pcs.



Bib Cock Long Body

RUGR-04 ₹ 280/-

 24 Pcs.  96 Pcs.



Sink Cock (Table Mounted)

RUGR-05 ₹ 535/-

 12 Pcs.  48 Pcs.



Sink Cock (Wall Mounted)

RUGR-06 ₹ 535/-

 12 Pcs.  48 Pcs.



2-Way Bib Cock

RUGR-08 ₹ 455/-

 24 Pcs.  96 Pcs.



2-Way Angular Stop Cock

RUGR-26 ₹ 425/-

 28 Pcs.  112 Pcs.

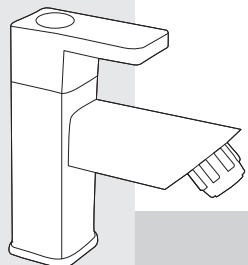

P.T.M.T
 (Polytetra Methylene Terephthalate)

 Small Box  Master Box



Pillar Cock

RUPM-01 ₹ 355/-

 24 Pcs.  96 Pcs.



Bib Cock

RUPM-02 ₹ 220/-

 48 Pcs.  192 Pcs.

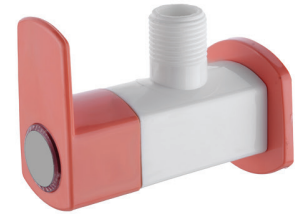

**Angular Stop Cock
 (02 PC Packing)**

RUPM-03 ₹ 210/-

 56 Pcs.  224 Pcs.

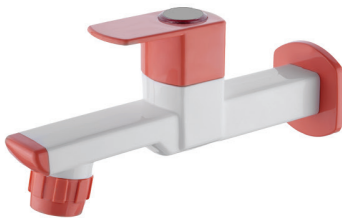

Bib Cock Long Body

RUPM-04 ₹ 280/-

 24 Pcs.  96 Pcs.



Sink Cock (Table Mounted)

RUPM-05 ₹ 535/-

 12 Pcs.  48 Pcs.



Sink Cock (Wall Mounted)

RUPM-06 ₹ 535/-

 12 Pcs.  48 Pcs.

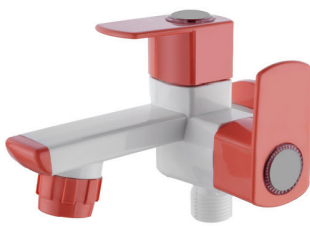

2-Way Bib Cock

RUPM-08 ₹ 455/-

 24 Pcs.  96 Pcs.



2-Way Angular Stop Cock

RUPM-26 ₹ 425/-

 28 Pcs.  112 Pcs.

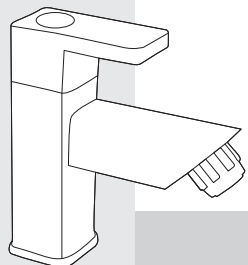

P.T.M.T
 (Polytetra Methylene Terephthalate)

 Small Box  Master Box



Pillar Cock

RUAQ-01 ₹ 355/-

24 Pcs. 96 Pcs.



Bib Cock

RUAQ-02 ₹ 220/-

48 Pcs. 192 Pcs.

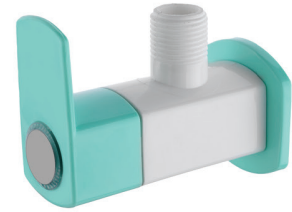

**Angular Stop Cock
 (02 PC Packing)**

RUAQ-03 ₹ 210/-

56 Pcs. 224 Pcs.



Bib Cock Long Body

RUAQ-04 ₹ 280/-

24 Pcs. 96 Pcs.



Sink Cock (Table Mounted)

RUAQ-05 ₹ 535/-

12 Pcs. 48 Pcs.



Sink Cock (Wall Mounted)

RUAQ-06 ₹ 535/-

12 Pcs. 48 Pcs.



2-Way Bib Cock

RUAQ-08 ₹ 455/-

24 Pcs. 96 Pcs.



2-Way Angular Stop Cock

RUAQ-26 ₹ 425/-

28 Pcs. 112 Pcs.

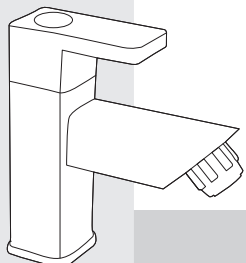

P.T.M.T
 (Polytetra Methylene Terephthalate)

Small Box Master Box



Pillar Cock

LAWH-01 ₹ 385/-

 10 Pcs.  80 Pcs.



Bib Cock

LAWH-02 ₹ 240/-

 24 Pcs.  144 Pcs.

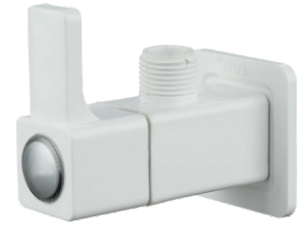

Angular Stop Cock (2 Pc Packing)

LAWH-03 ₹ 225/-

 48 Pcs.  288 Pcs.



Bib Cock Long Body

LAWH-04 ₹ 300/-

 24 Pcs.  144 Pcs.



Sink Cock (Table Mounted)

LAWH-05 ₹ 565/-

 10 Pcs.  80 Pcs.



Sink Cock (Wall Mounted)

LAWH-06 ₹ 565/-

 10 Pcs.  80 Pcs.



2-Way Bib Cock

LAWH-08 ₹ 485/-

 08 Pcs.  64 Pcs.



Wall Mixer With Overhead Shower System

EDWH-20 ₹ 1900/-

 04 Pcs.  24 Pcs.



2-Way Angular Stop Cock

LAWH-26 ₹ 445/-

 08 Pcs.  64 Pcs.

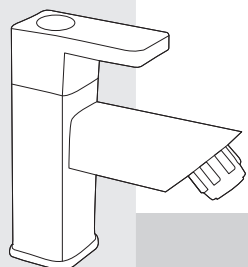

P.T.M.T
 (Polytetra Methylene Terephthalate)

 Small Box  Master Box



Pillar Cock

LAWBL-01 ₹ 385/-

10 Pcs. 80 Pcs.



Bib Cock

LAWBL-02 ₹ 240/-

24 Pcs. 144 Pcs.



Angular Stop Cock (2 Pc Packing)

LAWBL-03 ₹ 225/-

48 Pcs. 288 Pcs.

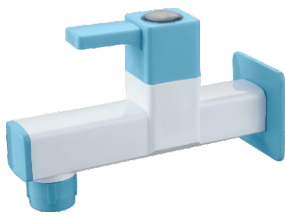

Bib Cock Long Body

LAWBL-04 ₹ 300/-

24 Pcs. 144 Pcs.



Sink Cock (Table Mounted)

LAWBL-05 ₹ 565/-

10 Pcs. 80 Pcs.



Sink Cock (Wall Mounted)

LAWBL-06 ₹ 565/-

10 Pcs. 80 Pcs.



2-Way Bib Cock

LAWBL-08 ₹ 485/-

08 Pcs. 64 Pcs.



Wall Mixer With Overhead Shower System

EDWBL-20 ₹ 1900/-

04 Pcs. 24 Pcs.



2-Way Angular Stop Cock

LAWBL-26 ₹ 445/-

08 Pcs. 64 Pcs.

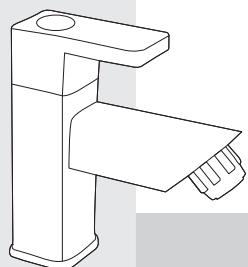

P.T.M.T
 (Polytetra Methylene Terephthalate)

Small Box Master Box



Pillar Cock

LAWGR-01 ₹ 385/-

 10 Pcs.  80 Pcs.



Bib Cock

LAWGR-02 ₹ 240/-

 24 Pcs.  144 Pcs.

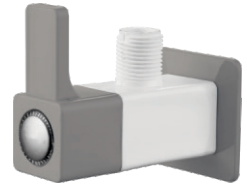

Angular Stop Cock (2 Pc Packing)

LAWGR-03 ₹ 225/-

 48 Pcs.  288 Pcs.



Bib Cock Long Body

LAWGR-04 ₹ 300/-

 24 Pcs.  144 Pcs.



Sink Cock (Table Mounted)

LAWGR-05 ₹ 565/-

 10 Pcs.  80 Pcs.



Sink Cock (Wall Mounted)

LAWGR-06 ₹ 565/-

 10 Pcs.  80 Pcs.



2-Way Bib Cock

LAWGR-08 ₹ 485/-

 08 Pcs.  64 Pcs.



2-Way Angular Stop Cock

LAWGR-26 ₹ 445/-

 08 Pcs.  64 Pcs.

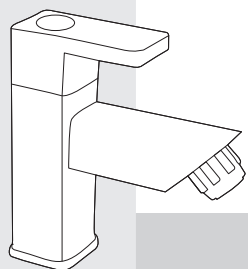

P.T.M.T
 (Polytetra Methylene Terephthalate)

 Small Box  Master Box



Pillar Cock

LAWBK-01 ₹ 385/-

10 Pcs. 80 Pcs.



Bib Cock

LAWBK-02 ₹ 240/-

24 Pcs. 144 Pcs.



Angular Stop Cock (2 Pc Packing)

LAWBK-03 ₹ 225/-

48 Pcs. 288 Pcs.



Bib Cock Long Body

LAWBK-04 ₹ 300/-

24 Pcs. 144 Pcs.



Sink Cock (Table Mounted)

LAWBK-05 ₹ 565/-

10 Pcs. 80 Pcs.



Sink Cock (Wall Mounted)

LAWBK-06 ₹ 525/-

10 Pcs. 80 Pcs.



2-Way Bib Cock

LAWBK-08 ₹ 485/-

08 Pcs. 64 Pcs.



Wall Mixer With Overhead Shower System

EDWBK-20 ₹ 1900/-

04 Pcs. 24 Pcs.



2-Way Angular Stop Cock

LAWBK-26 ₹ 445/-

08 Pcs. 64 Pcs.

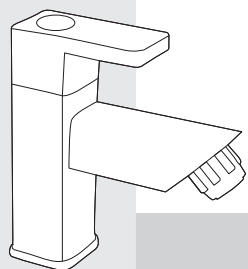

P.T.M.T
 (Polytetra Methylene Terephthalate)

Small Box Master Box



Pillar Cock

FUIV-01 ₹ 290/-

24 Pcs. 144 Pcs.



Bib Cock With Foam Flow

FUIV-021 ₹ 225/-

36 Pcs. 216 Pcs.



Bib Cock

FUIV-02 ₹ 200/-

36 Pcs. 216 Pcs.



Angular Stop Cock (2 Pc Packing)

FUIV-03 ₹ 195/-

48 Pcs. 288 Pcs.



Big Cock Long Body

FUIV-04 ₹ 250/-

24 Pcs. 144 Pcs.



Sink Cock (Table Mounted)

FUIV-05 ₹ 555/-

10 Pcs. 80 Pcs.



Sink Cock (Wall Mounted)

FUIV-06 ₹ 545/-

10 Pcs. 80 Pcs.



2-Way Bib Cock

FUIV-08 ₹ 455/-

08 Pcs. 64 Pcs.



Wall Mixer With Overhead Shower System

FUIV-20 ₹ 1900/-

04 Pcs. 24 Pcs.



2-Way Angular Stop Cock

FUIV-26 ₹ 430/-

08 Pcs. 64 Pcs.

P.T.M.T
 (Polytetra Methylene Terephthalate)

Small Box Master Box



Pillar Cock

FUIGN-01 ₹ 290/-

24 Pcs. 144 Pcs.



Bib Cock

FUIGN-02 ₹ 200/-

36 Pcs. 216 Pcs.

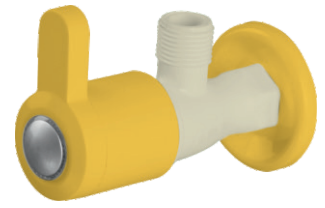

Angular Stop Cock
 (2 Pc Packing)

FUIGN-03 ₹ 195/-

48 Pcs. 288 Pcs.

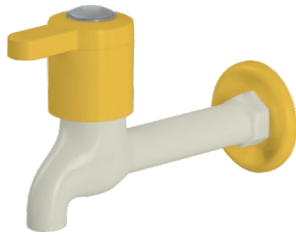

Bib Cock Long Body

FUIGN-04 ₹ 250/-

24 Pcs. 144 Pcs.



Sink Cock (Table Mounted)

FUIGN-05 ₹ 555/-

10 Pcs. 80 Pcs.



Sink Cock (Wall Mounted)

FUIGN-06 ₹ 545/-

10 Pcs. 80 Pcs.



2-Way Bib Cock

FUIGN-08 ₹ 455/-

08 Pcs. 64 Pcs.



2-Way Angular Stop Cock

FUIGN-26 ₹ 430/-

08 Pcs. 64 Pcs.

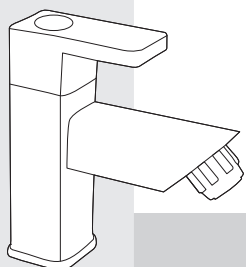

P.T.M.T
 (Polytetra Methylene Terephthalate)

Small Box Master Box



Pillar Cock

FUWBL-01 ₹ 290/-

24 Pcs. 144 Pcs.



Bib Cock With Foam Flow

FUWBL-021 ₹ 225/-

36 Pcs. 216 Pcs.



Bib Cock

FUWBL-02 ₹ 200/-

36 Pcs. 216 Pcs.



Angular Stop Cock (2 Pc Packing)

FUWBL-03 ₹ 195/-

48 Pcs. 288 Pcs.



Bib Cock Long Body

FUWBL-04 ₹ 250/-

24 Pcs. 144 Pcs.



Sink Cock (Table Mounted)

FUWBL-05 ₹ 555/-

10 Pcs. 80 Pcs.



Sink Cock (Wall Mounted)

FUWBL-06 ₹ 545/-

10 Pcs. 80 Pcs.



2-Way Bib Cock

FUWBL-08 ₹ 455/-

08 Pcs. 64 Pcs.



Wall Mixer With Overhead Shower System

FUWBL-20 ₹ 1900/-

04 Pcs. 24 Pcs.



2-Way Angular Stop Cock

FUWBL-26 ₹ 430/-

08 Pcs. 64 Pcs.



Nozzle | Washing Machine Bib Cock

FUWBL-45 ₹ 235/-

36 Pcs. 216 Pcs.



Pillar Cock

NEWH-01 ₹ 290/-

14 Pcs. 144 Pcs.



Bib Cock With Foam Flow

NEWH-021 ₹ 225/-

36 Pcs. 216 Pcs.



Bib Cock

NEWH-02 ₹ 200/-

36 Pcs. 216 Pcs.



Angular Stop Cock (2 Pc Packing)

NEWH-03 ₹ 195/-

48 Pcs. 288 Pcs.



Bib Cock Long Body

NEWH-04 ₹ 250/-

24 Pcs. 144 Pcs.



Sink Cock (Table Mounted)

NEWH-05 ₹ 555/-

10 Pcs. 80 Pcs.



Sink Cock (Wall Mounted)

NEWH-06 ₹ 545/-

10 Pcs. 80 Pcs.



2-Way Bib Cock

NEWH-08 ₹ 455/-

08 Pcs. 64 Pcs.



Wall Mixer With Overhead Shower System

NEWH-20 ₹ 1900/-

04 Pcs. 24 Pcs.



2-Way Angular Stop Cock

NEWH-26 ₹ 430/-

08 Pcs. 64 Pcs.



Nozzle | Washing Machine Bib Cock

NEWH-45 ₹ 235/-

36 Pcs. 216 Pcs.



Pillar Cock

NEWBL-01 ₹ 290/-

24 Pcs. 144 Pcs.



Bib Cock With Foam Flow

NEWBL-021 ₹ 225/-

36 Pcs. 216 Pcs.



Bib Cock

NEWBL-02 ₹ 200/-

36 Pcs. 216 Pcs.

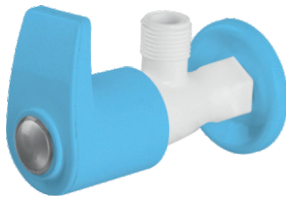

Angular Stop Cock (2 Pc Packing)

NEWBL-03 ₹ 195/-

48 Pcs. 288 Pcs.



Bib Cock Long Body

NEWBL-04 ₹ 250/-

24 Pcs. 144 Pcs.



Sink Cock (Table Mounted)

NEWBL-05 ₹ 555/-

10 Pcs. 80 Pcs.



Sink Cock (Wall Mounted)

NEWBL-06 ₹ 545/-

10 Pcs. 80 Pcs.



2-Way Bib Cock

NEWBL-08 ₹ 455/-

08 Pcs. 64 Pcs.

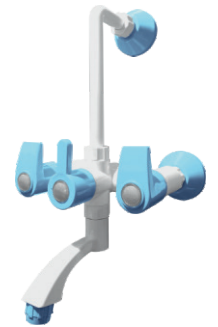

Wall Mixer With Overhead Shower System

NEWBL-20 ₹ 1900/-

04 Pcs. 24 Pcs.



2-Way Angular Stop Cock

NEWBL-26 ₹ 430/-

08 Pcs. 64 Pcs.



Nozzle | Washing Machine Bib Cock

NEWBL-45 ₹ 235/-

36 Pcs. 216 Pcs.



Pillar Cock

STIV-01 ₹ 270/-

24 Pcs. 144 Pcs.



Bib Cock

STIV-02 ₹ 185/-

36 Pcs. 216 Pcs.



Angular Stop Cock (2 Pc Packing)

STIV-03 ₹ 180/-

48 Pcs. 288 Pcs.



Bib Cock Long Body

STIV-04 ₹ 245/-

24 Pcs. 144 Pcs.



Sink Cock (Table Mounted)

STIV-05 ₹ 535/-

10 Pcs. 80 Pcs.



Sink Cock (Wall Mounted)

STIV-06 ₹ 525/-

10 Pcs. 80 Pcs.



2-Way Bib Cock

STIV-08 ₹ 425/-

08 Pcs. 64 Pcs.



2-Way Angular Stop Cock

STIV-26 ₹ 400/-

08 Pcs. 64 Pcs.

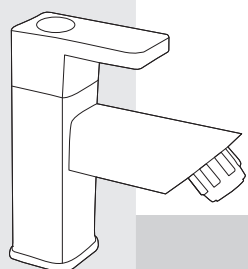

P.T.M.T
 (Polytetra Methylene Terephthalate)

Small Box Master Box



Pillar Cock

STWH-01 ₹ 270/-

24 Pcs. 144 Pcs.



Bib Cock

STWH-02 ₹ 185/-

36 Pcs. 216 Pcs.



Angular Stop Cock (2 Pc Packing)

STWH-03 ₹ 180/-

48 Pcs. 288 Pcs.



Bib Cock Long Body

STWH-04 ₹ 245/-

24 Pcs. 144 Pcs.



Sink Cock (Table Mounted)

STWH-05 ₹ 535/-

10 Pcs. 80 Pcs.



Sink Cock (Wall Mounted)

STWH-06 ₹ 525/-

10 Pcs. 80 Pcs.



2-Way Bib Cock

STWH-08 ₹ 425/-

08 Pcs. 64 Pcs.



2-Way Angular Stop Cock

STWH-26 ₹ 400/-

08 Pcs. 64 Pcs.

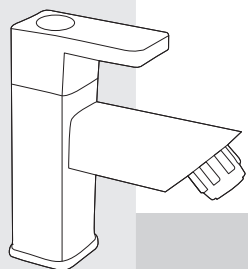

P.T.M.T
 (Polytetra Methylene Terephthalate)

Small Box Master Box



Pillar Cock

HFWH-01 ₹ 370/-

12 Pcs. 48 Pcs.



Bib Cock

HFWH-02 ₹ 180/-

28 Pcs. 112 Pcs.



Angular Stop Cock (2 Pc Packing)

HFWH-03 ₹ 180/-

56 Pcs. 224 Pcs.



Bib Cock Long Body

HFWH-04 ₹ 240/-

28 Pcs. 112 Pcs.



Sink Cock (Table Mounted)

HFWH-05 ₹ 535/-

12 Pcs. 48 Pcs.



Sink Cock (Wall Mounted)

HFWH-06 ₹ 525/-

12 Pcs. 48 Pcs.



2-Way Bib Cock

HFWH-08 ₹ 430/-

12 Pcs. 48 Pcs.



Wall Mixer With Overhead Shower System

HFWH-20 ₹ 1700/-

01 Pcs. 16 Pcs.



NOZZLE BIB COCK

HFWH-34 ₹ 250/-

28 Pcs. 112 Pcs.

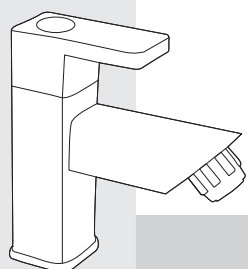

P.T.M.T
 (Polytetra Methylene Terephthalate)

Small Box Master Box



Pillar Cock

HFWBK-01 ₹ 370/-

12 Pcs. 48 Pcs.



Bib Cock

HFWBK-02 ₹ 180/-

28 Pcs. 112 Pcs.



Angular Stop Cock (2 Pc Packing)

HFWBK-03 ₹ 180/-

56 Pcs. 224 Pcs.



Bib Cock Long Body

HFWBK-04 ₹ 240/-

28 Pcs. 112 Pcs.



Sink Cock (Table Mounted)

HFWBK-05 ₹ 535/-

12 Pcs. 48 Pcs.



Sink Cock (Wall Mounted)

HFWBK-06 ₹ 525/-

12 Pcs. 48 Pcs.



2-Way Bib Cock

HFWBK-08 ₹ 430/-

12 Pcs. 48 Pcs.



Wall Mixer With Overhead Shower System

HFWBK-20 ₹ 1700/-

01 Pcs. 16 Pcs.



NOZZLE BIB COCK

HFWBK-34 ₹ 250/-

28 Pcs. 112 Pcs.

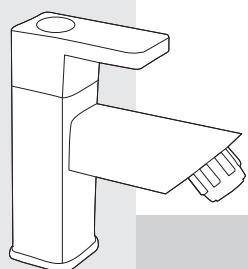

P.T.M.T
 (Polytetra Methylene Terephthalate)

Small Box Master Box

ABS SHOWER WITH ABS ARM



WASA-04 ₹ 335/-

Shower Size : 3"
 Arm Size : 9"

1 Pcs. 32 Pcs.



WASA-01 ₹ 375/-

Shower Size : 4"
 Arm Size : 9"

1 Pcs. 32 Pcs.



WASA-06 ₹ 430/-

Shower Size : 5"
 Arm Size : 9"

1 Pcs. 32 Pcs.



WASA-08 ₹ 340/-

Shower Size : 3"X3"
 Arm Size : 9"

1 Pcs. 32 Pcs.



WASA-09 ₹ 375/-

Shower Size : 4"X4"
 Arm Size : 9"

1 Pcs. 32 Pcs.

PTMT SHOWER WITH ARM



STSA-03 ₹ 335/-

Shower Size : 3"
 Arm Size : 9"

12 Pcs. 72 Pcs.



STSA-04 ₹ 400/-

Shower Size : 4" x 5"
 Arm Size : 9"

12 Pcs. 72 Pcs.



STSA-05 ₹ 400/-

Shower Size : 5"
 Arm Size : 9"

12 Pcs. 72 Pcs.



STSA-01 ₹ 400/-

Shower Size : 5"
 Arm Size : 9"

12 Pcs. 72 Pcs.



STSA-BK11 ₹ 400/-

Shower Size : 5"
 Arm Size : 9"

12 Pcs. 72 Pcs.



STSA-02 ₹ 400/-

Shower Size : 5"
 Arm Size : 9"

12 Pcs. 72 Pcs.



STSA-BK22 ₹ 400/-

Shower Size : 5"
 Arm Size : 9"

12 Pcs. 72 Pcs.

HEALTH FAUCETS



ABWHF - 001 ₹ 645/-

White Health Faucet With
 1 Mtr. Tube & Hook
 Material : ABS



ABWHF - 002 ₹ 610/-

White Health Faucet With
 1mtr. Tube & Hook
 Material : ABS



ABWHF - 003 ₹ 500/-

White | Blue Health
 Faucet with 1mtr. Tube & Hook
 Material: ABS



ABWHF 004 ₹ 500/-

White | Grey Health Faucet
 Faucet With 1mtr. Tube & Hook
 Material: ABS



ABWHF 005 ₹ 515/-

White Health Faucet
 Faucet With 1mtr. Tube & Hook
 Material: ABS



ABWHF 006 ₹ 645/-

Black Health Faucet
 Faucet With 1mtr. Tube & Hook
 Material: ABS



ABWHF 007 ₹ 705/-

Black Health Faucet
 Faucet With 1mtr. Tube & Hook
 Material: ABS

HEALTH FAUCETS



PTWHF -001 ₹ 500/-

White Health Faucet With 1 Mtr. Tube & Hook With Operating Key
 Material : PTMT



PTWHF -002 ₹ 450/-

White Health Faucet With 1mtr. Tube & Hook
 Material : PTMT



PTWHF-003 ₹ 450/-

White | Blue Health Faucet with 1mtr. Tube & Hook
 Material: PTMT



PTMT CONNECTION PIPE

(FOR COLD & HOT WATER SUPPLY UPTO 90°C)



CODE	SIZE	MRP	STANDARD PACKING
PTMT-012	12"/300MM	75	12Pcs
PTMT-018	18"/450MM	95	12Pcs
PTMT-024	24"/600MM	115	12Pcs
PTMT-030	30"/750MM	135	12Pcs
PTMT-036	36"/900MM	155	12Pcs

PTMT FLOOR TRAP



FTWPT-01 ₹ 125/-

Size : 150x150mm
Colour : White

45 Pcs. 180 Pcs.



Heavy Floor Trap

FTWPT-51 ₹ 200/-

Size : 150x150mm
Colour : White

45 Pcs. 180 Pcs.



Heavy Floor Trap With Grating

FTWPT-52 ₹ 285/-

Size : 150x150mm
Colour : White

12 Pcs. 48 Pcs.

ALLIED ACCESSORIES



Waste Coupling Full Thread 3"
Colour : White
Material : PTMT

CODE	MRP	STANDARD PACKING
PWC - 001	100/-	60 PCS



Heavy Collapsible Waste Pipe
With Coupler
(Magic Pipe)

CODE	MRP	STANDARD PACKING
CWP - 001 (36Inch)	100/-	75 PCS



Heavy Suction Waste
Pipe With Coupler
Colour : Ivory

CODE	MRP	STANDARD PACKING
SWP - 001 (36Inch)	80/-	60 PCS



Bottle Trap
Colour : White
Material : PTMT

CODE	MRP
PBT - 03	750/-



P.T.F.E. Thread Seal Tape
Size : 12mm
Length : 10 Mtrs.
Thickness : 0.1mm.

250 PCS 1000 PCS

CODE	MRP
TFT - 1210	30/-



PTMT Float Valve Heavy
With Epoxy Coated
Aluminium Rod
& HD Ball

CODE	SIZE	MRP	PACKAGES
FLOAT-15	1/2"-15mm	280/-	1 Pc
FLOAT-20	3/4"-20mm	320/-	1 Pc
FLOAT-25	1"-25mm	700/-	1 Pc

PRODUCT CATEGORY	PRODUCT DESCRIPTION	RESIDENTIAL USE (YEARS)	COMMERCIAL USE (YEARS)	
SANITARYWARE	Vitrious Ceramic Body (EWC's, Wash Basins, Urinals, Pedestals And Cisterns Etc.)	10	5	
SEAT COVERS	UF Seat Covers	2	1	
	PP Seat Covers	2	1	
INTERNAL FITTING	Internal Fitting & Accessories for Water Closet	2	1	
INTELLIGENT TOILET & TANKLESS TOILET	Electronic Parts & its Accessories	NIL	NIL	
DECORATED BASINS	Decorated Basins such as Matt, Sugar Matt, Designer, UF Basin, Decorated, Porcelain etc	NIL	NIL	
SENSOR URINAL	Ceramic Urinal Body	10	5	
	Sesor Based Flushing Systems-Electronic Assembly	1	0.5	
CONCEALED CISTERN	Concealed Cistern - Body	10	5	
	Concealed Cistern - Internal Fittings & Knobs	2	1	
EXPOSED CISTERN	Exposed Cistern - Body	2	1	
	Exposed Cistern - Internal Fitting & Knob	2	1	
GRAB BAR AND HAND RAIL	Grab Bar And Hand Rail	NIL	NIL	
BATH FITTING	CP Fitting Body (Faucets/ Diverters/Wall Mixers/Basin Mixers, Etc.)	10	5	
	CP Fitting Cartridge (Faucets/ Diverters/Wall Mixers/Basin Mixers)	2	1	
	Pressmatic Faucet and Mouth Operated Faucet Cartridge	1	0.5	
	Regular Metropole and Pressmatic Metropole Cartridge	1	0.5	
	Sensor Faucet / Electomic Parts	1	0.5	
	Stainless Steel and ABS Shower	1	0.5	
	Shower Arm, Connection Tube, Shower Hose, etc.	NIL	NIL	
	Health Faucet Set & Accessories	1	0.5	
	Architectural Drainage Solution and Shower Panels	1	0.5	
	Cp Fitting Accessories like Waste Coupling and Bottle Trap, etc	1	0.5	
	Extension Nipple	NIL	NIL	
	Allied Accessories & Floor Traps	NIL	NIL	
	Consumable Parts - Aerators, Batteries, Glass etc.	NIL	NIL	
	* For Surface Color Issues (Black, White, Gold Etc.) and Surface Galvanic Issues (Chrome Plating, Nickel Plating, Gold Plating, Etc.) The Warranty Term Shall in any case be Nil			
	PTMT COLLECTION (POLYTETRA METHYLENE TEREPHTHALATE)	PTMT Faucet Body	NIL	NIL
PTMT Faucet Cartridge		3	1	
PTMT Health Faucet Set		1	0.5	
Allied Accessories & PTMT Connection Pipe		NIL	NIL	
Consumable Parts - Aerators & Other Accessories Etc.		NIL	NIL	
BATHROOM ACCESSORIES	Bathroom Accessories Like Brass Body & SS Body	5	1	
	Bathroom Accessories Chrome	NIL	NIL	
KITCHEN SINK	Stainless Steel Sink - 304 Grade	10	5	
	Stainless Steel Sink Other Then 304 Grade	1	0.5	
	Stainless Steel Faucet And Accessories	NIL	NIL	
	Quartz Series	5	3	
	Food Waste Disposer	NIL	NIL	
WELLNESS	Spas, Whirlpools, Freestanding Bathtubs, Shower Rooms, Drop in Bathtubs.	NIL	NIL	
	Electric / Electronic Parts	NIL	NIL	
	Filters and Other Consumables Parts	NIL	NIL	
BATHROOM CABINET AND GLASS BOWL	Cabinet, Mirror, Faucet & Box Mirror	NIL	NIL	
	Glass Bowl	NIL	NIL	

We thank you for choosing Bell for your home/office and wish you a very pleasant experience. Although our products are made to work for much longer period than the warranty periods, proper installation by trained technician and maintenance of the products are needed to get optimum performance. • Bell will at its choice, repair, replace, or make appropriate adjustment where its inspection discloses any such defects occurring in normal usage as per terms mentioned below. Bell is not responsible for installation costs. • Bell reserves the right to examine product in question, and its installation, prior to replacement and will replace free of charge any part that proves defective in material and manufacturing workmanship under normal installation, use and service. • The warranty is applicable from the date of purchase. • The customer must produce the VAT/GST paid invoice/warranty card in original to avail warranty service. In case the purchase has been done by the developer of the apartment, the possession letter from the developer will be treated as equivalent to bill. • The company is not liable for any damage out of faulty installation. • Use of cement is not recommended for fixing this product, recommended to use screw and silicone/plastic washer for fixing, use water proof silicone sealant to cover the gap between product and floor. • The warranty becomes null and void if installation is not done by qualified and experienced technician and/or as per the installation procedure laid down by the company. • The company is also not liable to pay for any civil or construction work required during installation of new products or replacement/repair of old products. • The company is not liable for any consequential expenses or damages. • An equivalent replacement at pro-rata basis shall be provided in case the product has been discontinued, where in the customer has to pay proportionate amount on the current MRP, given the product is within the aforementioned warranty terms. • Warranty remains applicable only if the products have at all times been used strictly in accordance with the terms of this warranty and has not been improperly or negligently handled and is not maintained in accordance to maintenance guidelines given. • In the event of non-availability of components or parts due to any reason whatsoever Company or its Authorized Service provider or the Dealer will not be responsible or liable for any delay that may be caused to service/repair of the Products; no claims financial or otherwise will be entertained. • Company and customer agree that company will not be liable for any damages whatsoever arising out of use or inability to use its Company's Products. Bell bears no responsibility for incidental or consequential damages arising out of use or inability to use Company Product. • By purchasing this product, customer agrees to Company's aforesaid warranty on the product. • Company shall not be liable to Customer claiming the warranty under the terms of condition of this Limited Warranty Certificate, due to effects caused by rodents/pets or in the events of force majeure. The Force Majeure means any disaster, act of God or the public enemy, any accident, explosion, fire, storm, earthquake, electric storms, tornado, flood, casualty, lockout, strike, labor conditions, unavoidable accident, nuclear explosion, national calamity, or any other circumstance or event or by any enactment of law, or by order of any legally constituted authority, or by any other similar cause of the Company or beyond the reasonable control of the party relying upon such circumstance or event. • Company and customer agree that Bell bears no responsibility for incidental and / or consequential damage arising out of use and for inability to use a product. Company liability will be limited and restricted to the product replacement/value of the product sold. Company under all circumstances shall not be liable to uninstall the defective product or installed replacement product. In case replacement is the only option then the customer has to hand over the defective product to the seller from whom it was purchased and take the replacement product from there.



SAFETY PACKED, QUALITY STACKED!

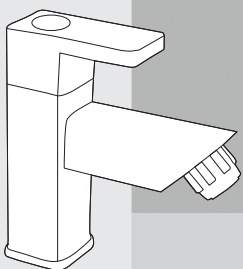



Bell Sanitarywares (Gujarat) INDIA
Customer Care: 1800 120 5755
Email: bellsanitarywares@gmail.com
www.bellsanitary.com

Maximum Retail Pricelist No.04 effective from October 2025